







**AGROLUX**

ИЗОБРАЖЕНИЕ	ОРИГ. №	KG
<b>ЛЕМЕЖИ</b>		
	85 004	3,000
	85 194	3,000
	85 039	3,200
	85 195	3,200
	85 381	4,400
	85 383	4,400
	85 382	4,500
	394 0345M1	4,500
	85 384	4,500
	394 0347M1	4,500
HE	94 598	3,300
HE	94 599	3,300
	94 600	4,100
	94 601	4,100
	94 602	3,900
	94 603	3,900
	84 942	2,200
	85 204	2,200

ИЗОБРАЖЕНИЕ	ОРИГ. №	KG
<b>ГЪРДИ</b>		
	94 596	1,400
	94 597	1,400

<b>ОТМЕТАТЕЛНИ ДЪСКИ</b>		
	94 594	16,900
	94 595	16,900

<b>ОТМЕТАТЕЛНИ ДЪСКИ ПРЕДПЛУЖНО ТЯЛО</b>		
	91 803	2,100
	91 804	2,100

**DIN-Teile**

ИЗОБРАЖЕНИЕ	ОРИГ. №	KG
<b>ПЛЪЗЦИ</b>		
	K 1063	2,700
	K 1073	2,700
	K 1083	3,600
	K 1093	3,600
	L 1063	3,400
	L 1073	3,400
	L 1083	5,500
	L 1093	5,500

ИЗОБРАЖЕНИЕ	ОРИГ. №	KG
<b>ЛЕМЕЖИ</b>		
HE	384 S	2,800
HE	436 S	3,100
HE	KMF257 C RE	3,300
HE	SS 1080-3	4,500
HE	SS 1090-3	4,500
HE	SS 1100	4,600
HE	SS 1110	4,600
HE	SS 1140	4,900
HE	SS 1150	4,900
HE	SS 1180-3	4,200

<b>ЛЕМЕЖИ ЗА ПРЕДПЛУЖНО ТЯЛО</b>		
	FR2 L	1,100
	FR2 R	0,500

<b>ОТМЕТАТЕЛНИ ДЪСКИ</b>		
HE	HST 1120	11,500
HE	HST 1130	11,500
HE	HST 1160	13,900
HE	HST 1170	13,900
HE	HST1120/3	12,000
HE	HST1130/3	12,000
HE	HST1160/3	13,700
HE	HST1170/3	13,700

<b>ГЪРДИ</b>		
HE	VST 1060	1,300
HE	VST 1120 Cv000045	1,600
HE	VST 1130 Cv000046	1,600
HE	VST 1160 Cv000047	1,700
HE	VST 1170 Cv000048	1,700

**ЕВЕРНАРТ**

ИЗОБРАЖЕНИЕ	ОРИГ. №	KG
<b>ПЛЪЗЦИ</b>		
	110 210	3,000
	110 211	3,000
	110 222	5,500
	110 223	5,500
	301 162	4,000

<b>ГЪРДИ</b>		
	301 160	2,000
	301 161	2,000
	301 668	1,100
	301 669	1,100
	40 002	2,000
	40 003	2,000

<b>ОТМЕТАТЕЛНИ ДЪСКИ ЗА ПРЕДПЛУЖНО ТЯЛО</b>		
	22003 0	3,000

<b>ШИЛА ЗА ПРЕДПЛУЖНО ТЯЛО</b>		
	302 490	2,300
	302 491	2,300

ИЗОБРАЖЕНИЕ	ОРИГ. №	KG
<b>ЛЕМЕЖИ</b>		
	54 550	5,100
	54 554	5,200
	54 555	5,200
	54 560	4,700
	55 584	5,000
	305 129	5,500
	306193/306195	5,500
	305 130	5,500
	306194/306196	5,500

<b>ЛЕМЕЖИ ЗА ПРЕДПЛУЖНО ТЯЛО</b>		
	22 024	1,100
	22 025	1,100
	22 602	1,000
	22 603	1,000

<b>ОТМЕТАТЕЛНИ ДЪСКИ</b>		
	HMW 254 L	16,600
	HMW 254 R	16,600
	HMW 284 L	20,800
	HMW 284 R	20,800

**ГРЕГОИРЕ БЕССОН**

ИЗОБРАЖЕНИЕ	ОРИГ. №	KG
<b>ПЛЪЗЦИ</b>		
	172321	2,600
	172380	5,300
	173333 / 4	2,500
	173337 / 8	2,500
	173388	2,500
	177 349	2,000

<b>РЕЖЕЩИ КРИЛА</b>		
	173323	1,500
	173324	1,500

ИЗОБРАЖЕНИЕ	ОРИГ. №	KG
<b>ЛЕМЕЖИ ЗА ПРЕДПЛУЖНО ТЯЛО</b>		
	19111	1,100
	19112	1,100
	19113	1,600
	19114	1,600
	19125	2,100
	19126	2,100

<b>ШИЛА</b>		
	173331	2,100
	173332	2,100
	173341 Diamant	2,000
	173342 Diamant	2,000

**ГУМИ РЕТЛАС**

TRAILER



FORESTRY-FLOTATION



**АКУМУЛАТОРИ MUTLU**



MUTLU Mega Calcium	РАЗМЕРИ / мм			ТЕГЛО кг
	Д	Ш	В	
12V 135Ah 950A	513	186	195	36,7
12V 165Ah 1100A	513	223	195	43,0
12V 190Ah 1250A	513	223	195	48,7
12V 200Ah 1250A	518	273	215	57,5
12V 225Ah 1450A	518	273	216	63,0
12V 240Ah 1500A	518	273	216	64,0

MUTLU Silver	РАЗМЕРИ / мм			ТЕГЛО кг
	Д	Ш	В	
12V 44Ah 360A	207	175	175	11,6
12V 47Ah 420A	207	175	175	12,0
12V 50Ah 450A L/R	207	175	190	12,6
12V 55Ah 450A	242	175	190	14,4
12V 55Ah 510A	242	175	175	14,2
12V 60Ah 520A	242	175	190	15,0
12V 63Ah 550A L/R	242	175	190	15,7
12V 75Ah 720A L/R	278	175	190	18,4
12V 80Ah 700A	315	175	175	20,2
12V 90Ah 850A	315	175	190	22,0
12V 100Ah 850A	353	175	190	23,5

**PETLAS**

**TRACTOR FRONT**



**TRACTOR REAR**



**TRACTOR RADIAL - ROW CROP**



**HARVESTER**



**GREGOIRE BESSON**

ИЗОБРАЖЕНИЕ	ОРИГ. №	KG
<b>ОТМЕТАТЕЛНИ ДЪСКИ</b>		
	173403	15,500
	173404	15,500
	173483	11,500
	173484	11,500
	173435	11,500
	173436	11,500
	173479	15,500
	173480	15,500

ИЗОБРАЖЕНИЕ	ОРИГ. №	KG
<b>ЛЕНТИ ЗА ОТМЕТАТЕЛНИ ДЪСКИ</b>		
	178105	3,100
	178106	3,100
	178107	2,700
	178108	2,700
	178109	2,800
	178110	2,800
	178111	6,500
	178112	6,500

ИЗОБРАЖЕНИЕ	ОРИГ. №	KG
<b>РЕЗЦИ</b>		
	171207 30x30	5,300
	172330 35x35	7,100

ИЗОБРАЖЕНИЕ	ОРИГ. №	KG
<b>ОТМЕТАТЕЛНИ ДЪСКИ ЗА ПРЕДПЛУЖНО ТЯЛО</b>		
	19171	1,600
	19172	1,600

ИЗОБРАЖЕНИЕ	ОРИГ. №	KG
<b>ПЕТИ</b>		
	172311	1,500
	172312	1,500

ИЗОБРАЖЕНИЕ	ОРИГ. №	KG
<b>ЛЕМЕЖИ</b>		
	173423	5,400
	173424	5,400
	173613	5,900
	173614	5,900
	177601	6,700
	177602	6,700
	178125	6,500
	178126	6,500
	172401	4,500
	172402	4,500
	172417	4,500
	172418	4,500
172613	5,000	
172614	5,000	

ИЗОБРАЖЕНИЕ	ОРИГ. №	KG
<b>ГЪРДИ</b>		
	173321	2,400
	173322	2,400
	173325	1,900
	173326	1,900
	173345	1,900
	173346	1,900
	173475	2,100
	173476	2,100
	178113	3,800
	178114	3,800

**KRONE**

ИЗОБРАЖЕНИЕ	ОРИГ. №	KG
<b>ПЛЪЗЦИ</b>		
	1231603	4,100
	1231613	4,100
	1231643	6,000
	1231653	6,000
	1230293	2,500
1231593	2,500	

ИЗОБРАЖЕНИЕ	ОРИГ. №	KG
<b>ЗЪБИ</b>		
	9290990	1,100
	9291990	1,100

ИЗОБРАЖЕНИЕ	ОРИГ. №	KG
<b>ЛЕМЕЖИ ЗА ПРЕДПЛУЖНО ТЯЛО</b>		
	9290900	1,100
	9291900	1,100
	9290910	0,900
	9291910	0,900
	9290920	1,100
	9291920	1,100

**KRONE**

ИЗОБРАЖЕНИЕ	ОРИГ. №	KG
<b>ЛЕМЕЖИ</b>		
	9290070	4,900
	9291070	4,900
	9290090	5,500
	9291090	5,500
	9290360	4,700
	9291360	4,700
	9290290	5,200
	9291290	5,200

ИЗОБРАЖЕНИЕ	ОРИГ. №	KG
<b>ГЪРДИ</b>		
	9294050	1,800
	9294250	1,800
	HE 9294070	1,800
	HE 9294270	1,800
	HE 9294150	2,000
	HE 9294350	2,000
	HE 9294360	1,900
	HE 9294030	1,800
	HE 9294230	1,800

**KUHN**



ИЗОБРАЖЕНИЕ	ОРИГ. №	KG
<b>ЛЕНТИ ЗА ЛЕНТОВА ДЪСКА</b>		
	617100	3,700
	617101	3,700
	617102	4,500
	617103	4,500
	617104	3,400
	617105	3,400
	617106	3,100
	617107	3,100



ИЗОБРАЖЕНИЕ	ОРИГ. №	KG
<b>ЛЕНТИ ЗА ЛЕНТОВА ДЪСКА</b>		
	H040 3180	4,000
	H040 3190	4,000
	H040 3200	4,500
	H040 3210	4,500
	H040 3220	5,000
	H040 3230	5,000
	H040 3240	7,200
	H040 3250	7,200

<b>ШИЛА</b>		
	622128	1,800
	622129	1,800
	622180	1,600
	622181	1,600

<b>ДЪСКИ ЗА ПРЕДПЛУЖНО ТЯЛО</b>		
	618104	2,000
	618105	2,000
	619126	2,100
	619127	2,100
	619132	4,000
	619133	4,000

<b>ЪГЛОСЛИМИ</b>		
	619122	3,100
	619123	3,100

<b>НОЖОВЕ (ЗАВАРЯЩИ СЕ)</b>		
	645255 L	0,700
	645225 R	0,700

<b>ПЕТИ</b>		
	648102	5,100
	648103	5,100

**НОЖЧЕТА**

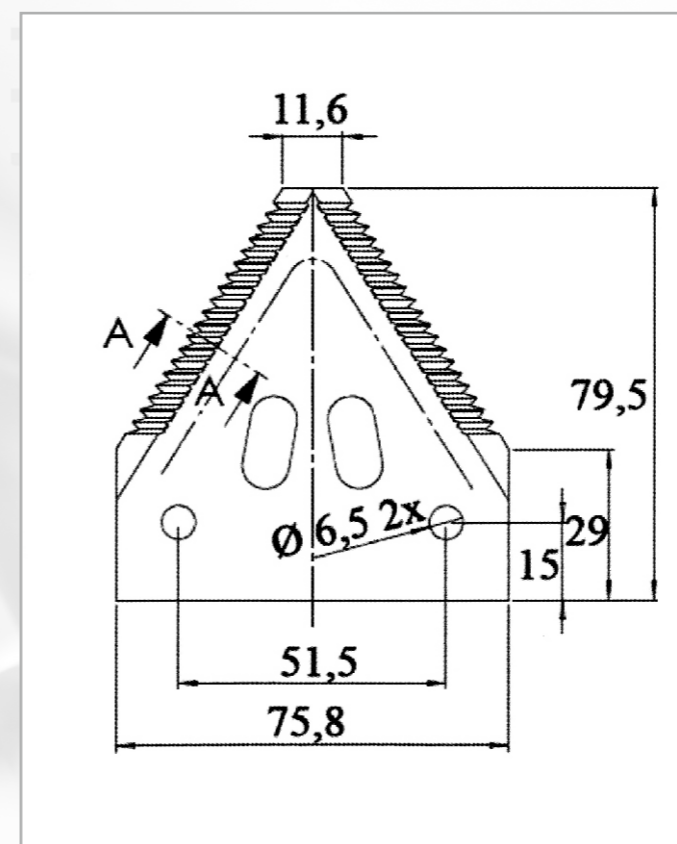
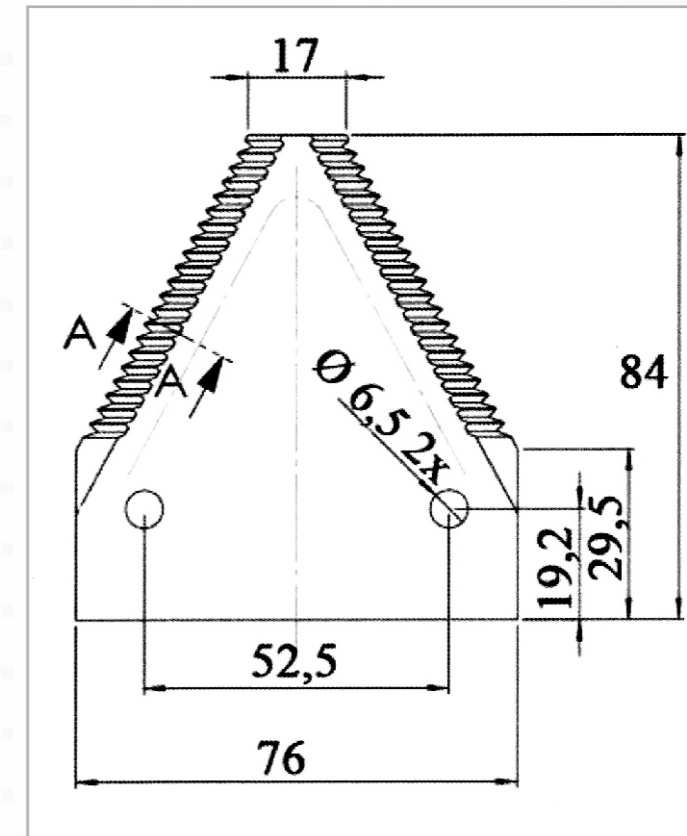
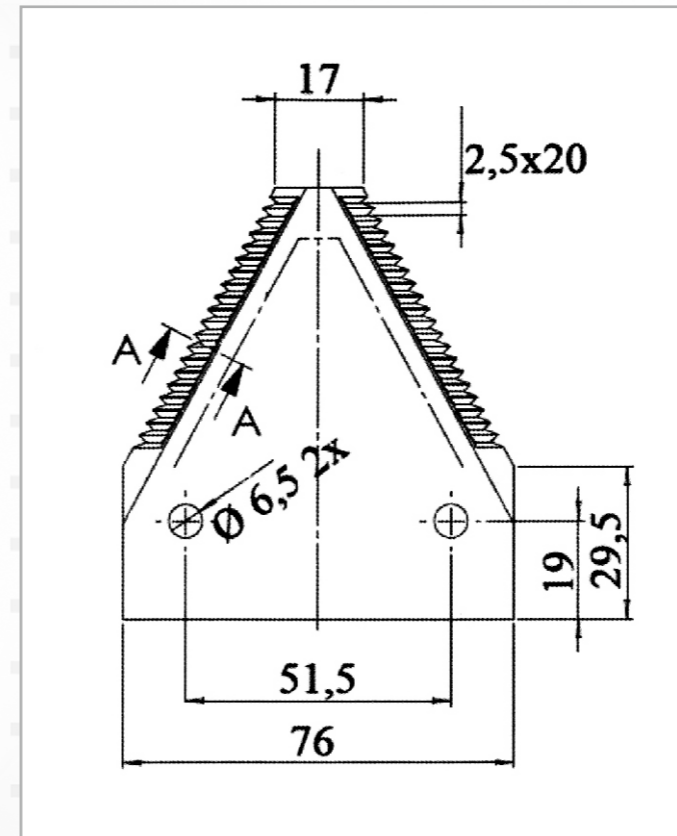

ПАЛЦИ

CLAAS 626235



CLAAS 626295



New Holland 80379720

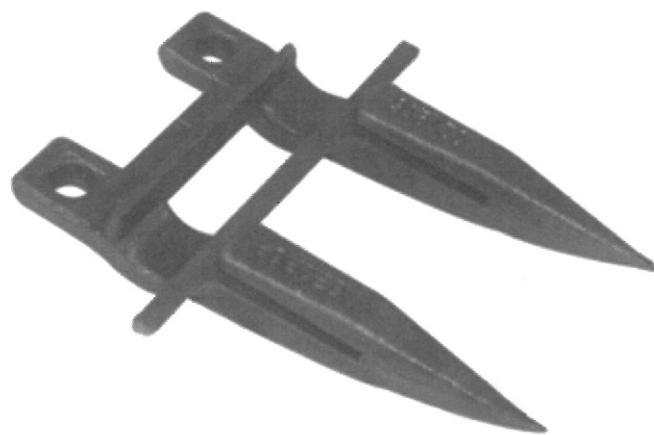

John Deere 410 100 001



John Deere Z.11228



Laverda 321115050



KUHN

ИЗОБРАЖЕНИЕ	ОРИГ. №	KG
<b>ПЛЪЗЦИ</b>		
	278070	3,600
	278071	3,600
	278074	3,000
	278075	3,000
	278076	4,700
	278077	4,700
	279028	3,000
	279029	3,000
	279030	3,900
	279031	3,900
	279114	5,800
	279115	5,800
	279126	2,900
	279127	2,900
	279130	4,700
	279131	4,700
	279140	5,400
	279152	2,400
	761108	4,600

<b>ОТМЕТАТЕЛНИ ДЪСКИ</b>		
	612108 Rh4	17,000
	612109 Lh4	17,000
	612110	17,300
	612111	17,300
	616074	12,000
	616075	12,000
	616092	15,500
	616093	15,500
	616104	15,500
	616105	15,500
	616138	17,700
	616139	17,700
	616190	13,500
	616191	13,500

ИЗОБРАЖЕНИЕ	ОРИГ. №	KG
<b>ЛЕМЕЖИ ПРЕДЛУЖНО ТЯЛО</b>		
	631 102	1,200
	631 103	1,200
	631 100	1,500
	631 101	1,500
	631 104	1,800
	631 105	1,800
	631 106	1,100
	631 107	1,100
	631 108	1,400
	631 109	1,400
	632 002	0,500
	632 003	0,500

<b>ЗАЩИТИ ЗА ПЛЪЗЦИ</b>		
	226100	4,500
	226104	4,500

<b>ВЪРХОВЕ ЗА ПЛЪЗЦИ</b>		
	279138	0,900
	279139	0,900
	223120	0,900
	223121	0,900
	761106	0,800
	761107	0,800
	761110	0,800
	761111	0,800

**KUHN**

ИЗОБРАЖЕНИЕ	ОРИГ. №	KG	ИЗОБРАЖЕНИЕ	ОРИГ. №	KG
<b>ЛЕМЕЖИ</b>			<b>ГЪРДИ</b>		
	580884	7,000		619038	2,000
	581140			619039	2,000
	583102			619060	1,500
	580885	7,000		619061	1,500
	581141			619068	1,300
	583103			619069	
	580886	7,500		619120 RH4	2,300
	581416			619168	
	583818			619121 LH4	2,300
	580887	7,500		619169	
	581417			619172	
	583819			619173	2,800
	583892	6,500		619200	1,600
	583893			619201	
	622134			6,500	619201 H040178
	622166	6,500		619201 H040179	1,600
	622135			619278	2,400
	622167			619278 H040 3520	2,400
	622136	6,800		619279	2,400
	622172			619279 H040 3530	
	622212			6,800	919068
	622137	6,800	<b>ЛЕМЕЖИ</b>		
	622173		622235	5,700	
	622213		622330	6,000	
	622140	6,300		622331	6,000
	622141			625102	5,100
	622142			625103	5,100
	622143	6,600	<b>НОЖОВЕ ЗА ПЪЛЗЕЦ</b>		
	622234		073088	3,500	
			073089		
		0,900		084320	3,500
				084321	

**KVERNELAND**

ИЗОБРАЖЕНИЕ	ОРИГ. №	KG	ИЗОБРАЖЕНИЕ	ОРИГ. №	KG
<b>ЗАЩИТИ ЗА ПЪЛЗЕЦ</b>			<b>НОЖОВЕ ЗА ПЪЛЗЕЦ</b>		
	063600	1,500		073088	3,500
	063601R/L	3,900		073089	
	073614	0,900		084320	3,500
		084321			

**ТЕГЛИЧИ**

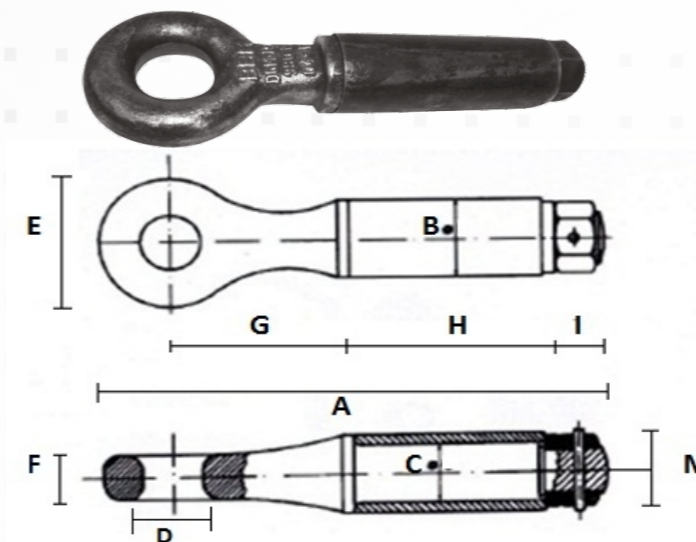

sistema di controllo nel processo produttivo

**CUNA**  
NC 090-15



**UNACOMA**  
Unione Nazionale Costruttori  
Macchine Agricole



associazione industriale bresciana



**Италиански тегличичи BVM със сертификат за качество**

A	B	C	D	E	F	G	H	I	M	до
283	42	30	40	85	24	100	110	20	M27	2500 kg
343	51	45	45	105	31	96	150	40	M30	4000 kg
343	57	45	45	105	31	96	150	40	M31	7000 kg
343	63	45	45	105	38	100	147	40	M33	10000kg

**КАРДАНИ**

**Изображение**



**Характеристики**

Доставка на карданни валове за всички видове селско стопанска техника и прикачен инвентар. Издаваме декларация за съответствие валидна за Република България и целия Европейски съюз.

**Карданни валове (каре 35x82)**

1. Карданен вал с шлицево телескопиране (шлицев вал и шлицева втулка).
2. Карданен вал с квадратно телескопиране (квадрат и квадратна втулка).
3. Карданен вал с профилна тръба.

\*И трите вида карданни валове се изработват по желана от клиента дължина и карайни вилки с 6 / 8 / 21 зъба или шпонка.

**Отделно се предлагат всички прилежащи детайли по карданния вал:**

1. Вилка крайна - 6 / 8 / 21 зъба или шпонка (различни размери)
2. Вилка вътрешна за тръба, за квадрат или за шлицев вал.
3. Квадрат.
4. Шлицев вал.
5. Втулка (квадратна или шлицева).
6. Профилна тръба.
7. Каре различни размери.
8. Шарнир.
9. Пластмасов кожух.

КРЕПЕЖНИ ЕЛЕМЕНТИ

БОЛТОВЕ С КОНУСНА ГЛАВА ЕДНОСТРАННО СКОСЕНИ И КЛАС НА ЯКОСТ 12.9 В КОМПЛЕКТ С ГАЙКА С КЛАС НА ЯКОСТ 10

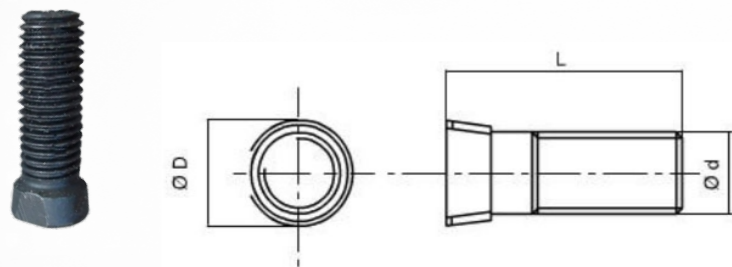

Описание	
М 12x33(12.9)	
М 12x37(12.9)	
М 12x42(12.9)	
М 12x52(12.9)	
М 14x33(12.9)	
М 14x37(12.9)	
М 14x42(12.9)	
М 14x50(12.9)	

БОЛТОВЕ С КОНУСНА ГЛАВА ДВУСТРАННО СКОСЕНИ И КЛАС НА ЯКОСТ 12.9 В КОМПЛЕКТ С ГАЙКА С КЛАС НА ЯКОСТ 10

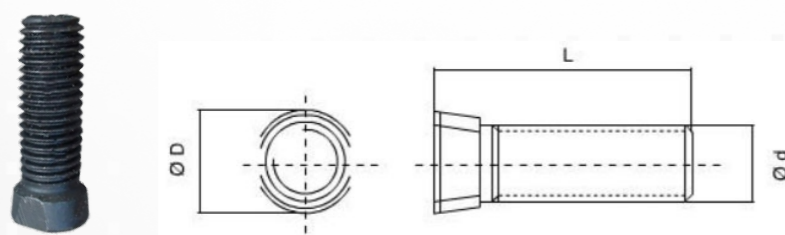

Описание	
М 12x35(12.9) 15°	
М 12x40(12.9) 15°	
М 12x50(12.9) 15°	
М 12x40(12.9) 30°	
М 14x39(12.9) 30°	
М 14x34(12.9) 15°	

КУЛТИВАТОРНИ БОЛТОВЕ С ЕЛЕПСОВИДНА ГЛАВА И КЛАС НА ЯКОСТ 8.8 В КОМПЛЕКТ С ГАЙКА С КЛАС НА ЯКОСТ 8

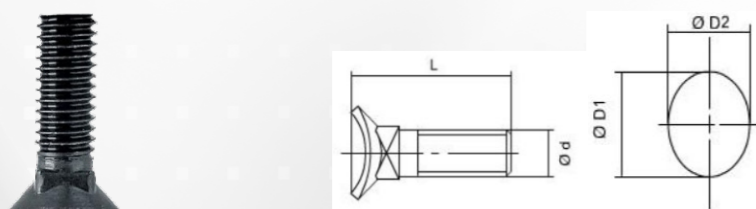

Описание	
М 10x38(8.8)	
М 10x45(8.8)	
М 12x48(8.8)	
М 12x55(8.8)	



KVERNELAND

ИЗОБРАЖЕНИЕ	ОРИГ. №	KG
<b>ПЛЪЗЦИ</b>		
	073608-12mm	5,500
	073609-12mm	
	073601	8,000
	073611	
	053684	5,700
	063601R/L	7,500
	063603	6,000
	063604	6,000
	063605	4,000
	063606	4,000
	063610R/L	5,500
	063611R/L	8,600
	063615	4,000
	073609	5,500
	073612	8,000
	073613	8,000

<b>ГЪРДИ</b>		
	063240	1,100
	063250	1,100
	073230	1,800
	073231	1,800
	073250	1,400
	073251	1,400
	073256	1,600
	073257	1,600

<b>ШИЛА</b>		
	053090	1,800
	063090	1,800

<b>ЪГЛОСЛИМИ</b>		
	073300	3,300
	073301	3,300

<b>ПЕТИ</b>		
	053387	1,900
	063388	1,900

ИЗОБРАЖЕНИЕ	ОРИГ. №	KG
<b>ЛЕМЕЖИ</b>		
	063014	5,000
	063017	5,000
	063015	5,300
	063018	5,300
	063023	4,900
	073002	5,000
	073003	5,000
	073004	5,500
	073005	5,500
	073006	6,100
	073007	6,100
	073056	5,200
	073057	5,200
	073080	6,300
	073081	6,300
	073084	6,100
	073085	6,100

<b>ДЪСКИ ЗА ПРЕДПЛУЖНО ТЯЛО</b>		
	066880	1,600
	066881	1,600
	076812	2,500
	076813	2,500

<b>ДЪРЖАЧ ЗА ЪГЛОСЛИМ</b>		
	073310	2,300
	073311	2,300

<b>РЕЖЕЩИ КРИЛА</b>		
	073091	0,800
	073092	0,800

**KVERNELAND**

ИЗОБРАЖЕНИЕ	ОРИГ. №	KG
<b>ЛЕНТИ ЗА ЛЕНТОВА ДЪСКА</b>		
	083211	6,900
	083221	6,900
	083212	5,300
	083222	5,300
	083213	4,400
	083223	4,400
	083214	3,600
	083224	3,600

ИЗОБРАЖЕНИЕ	ОРИГ. №	KG
<b>ЛЕМЕЖИ ЗА ПРЕДПЛУЖНО ТЯЛО</b>		
	056873	1,000
	066868	1,500
	066869	1,500
	066873	1,300
<b>ОТМЕТАТЕЛНИ ДЪСКИ</b>		
	063261	19,800
	063283	19,800
	073286	20,700
	073287	20,700
	073290	20,700
	073291	20,700

<b>РЕСОРНА ЗАЩИТА</b>			
ИЗОБРАЖЕНИЕ	ОРИГ. №	РЕФЕРЕНТЕН №	KG
	057063	12500-H0	3,500
	057064	12500-H1	3,400
	057065	12500-H2	2,800
	057066	12500-H3	2,000
	057067	12500-H4	0,700
	057068	12500-H5	2,800
		12500-PC	0,373
		2500-PR	0,306
	060703	12500-5 = 12500 HO + 12500-H1 + 12500H2 + 12500-H3 + 12500H4	16,500
	060703	12500-7 = 12500 HO + 12500-H1 + 12500H2 + 12500-H3 + 1250H4 + 12500-H5	22,100

**КРЕПЕЖНИ ЕЛЕМЕНТИ**

**БОЛТОВЕ DIN 608 В КОМПЛЕКТ С ГАЙКИ**

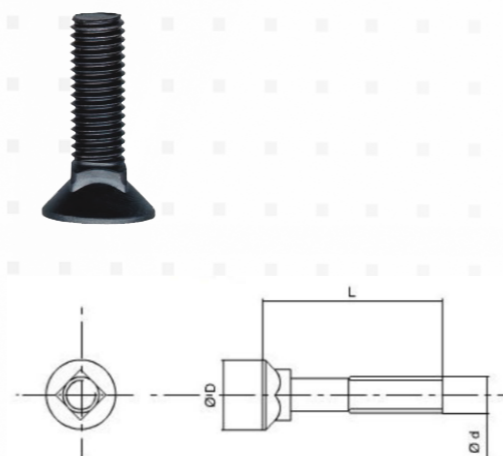

	Цени на DIN 608 + гайка в лева					
	M9	M10	M11	M12	M14	M16
25	0.40	0.42				
30	0.41	0.43	0.54	0.59		
35	0.43	0.45	0.57	0.68	1.14	
40	0.45	0.46	0.59	0.72	1.19	1.65
45	0.47	0.49	0.60	0.75	1.24	1.73
50	0.49	0.51	0.61	0.78	1.29	1.81
55		0.55	0.63	0.82	1.55	1.89
60		0.58	0.65	0.84	1.61	1.97
70		0.63	0.76	0.91	1.70	2.09
80		0.69	0.84	0.97	1.80	2.15
90			0.92	1.03	1.90	2.33
100			1.00	1.15	2.00	2.42
Бр/кутия	100	50	50	50	25	25

**БОЛТОВЕ DIN 608 ТИП, "В" - КЛАС НА ЯКОСТ 12.9 И 10.9 В КОМПЛЕКТ С ГАЙКИ С КЛАС НА ЯКОСТ СЪОТВЕТНО 10 И 8**

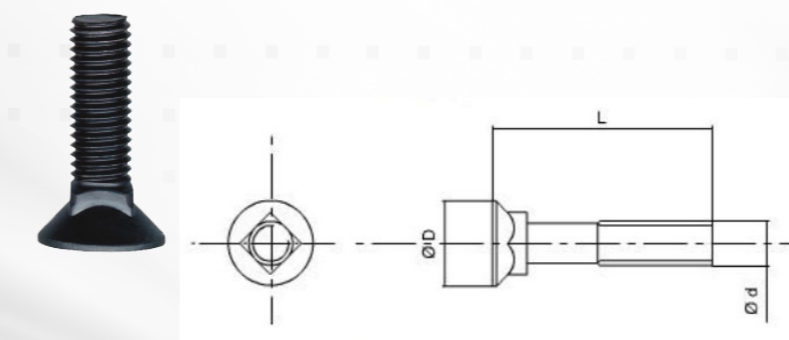

Описание
М 10x25(12.9)
М 10x30(12.9)
М 10x35(12.9)
М 12x40(12.9)
М 12x50(12.9)
М 12x55(12.9)
М 12x60(12.9)
М 12x70(12.9)
М 12x80(12.9)
М 12x90(12.9)
М 14x40(10.9)
М 14x50(10.9)

**БОЛТ СЪС СКРИТА ГЛАВА, 2 ЗАДЪРЖАЩИ ЧОПА И КЛАС НА ЯКОСТ 8.8 В КОМПЛЕКТ С ГАЙКА С КЛАС НА ЯКОСТ 8**

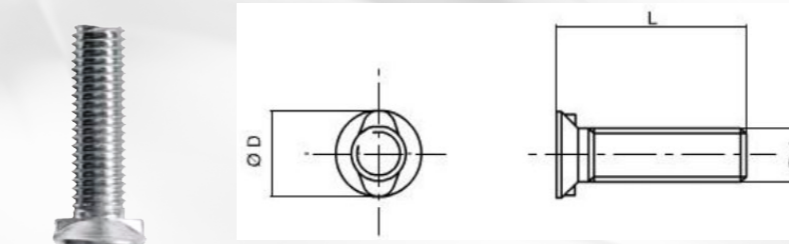



Описание
М 10x30(8.8) p
М 12x37(8.8) p
М 12x40(8.8) c
М 12x45(8.8) c
М 14x35(8.8) p
М 14x40(8.8) c



ЛАГЕРНИ ТЕЛА

				
Лагерно тяло за БДТ 3 Попово	Лагерно тяло за БДТ 7 Попово	Лагерно тяло за БДТ 5	Лагерно тяло за БДТ 4	Лагерно тяло к-т Новозагорско
Чугун	Стомана	Чугун	Стомана	Стомана

	<b>Лагерно тяло за Kuhn, Galucho и др.</b> Лагерно тяло от стомана с 2 конусни лагера. Подходящо за дискови брани Kverneland, Quevogne, Razol, Frost, Rau и други европейски марки с ос 40x40
	<b>Лагерно тяло за Kuhn, Galucho и др.</b> Лагерно тяло от стомана с 2 конусни лагера. Подходящо за дискови брани Galucho, Kuhn, Gregoire Besson, Soushu-Pinet, Dal-Bo и други европейски марки с ос 40x40

ЛАГЕРИ



















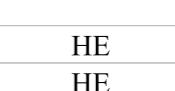



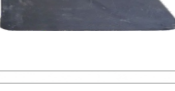
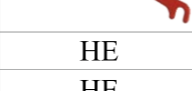



















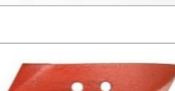



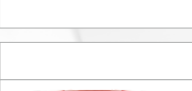

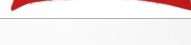
РОЛКОВИ ЛАГЕРИ

ЛАГЕРНИ ТЕЛА UCSF

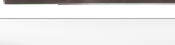
ЛАГЕРНИ ТЕЛА UCSR

					
Номер	Ø	Номер	Ø	Номер	Ø
РОЛКОВ ЛАГЕР	13,800	UCSF 204	20	UCF 204	20
КАПАЧКА		UCSF 205	25	UCF 205	25
ВТУЛКА		UCSF 206	30	UCF206	30
		UCSF 207	35	UCF 207	35
		UCSF 208	40	UCF 208	40
		UCSF 209	45	UCF 209	45
		UCSF 210	50	UCF 210	50
		UCSF 211	55	UCF 211	55
		UCSF 212	60	UCF 212	60
		UCSF 214	70	UCF 214	70

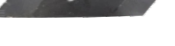
LANDSBERG PÖTTINGER

ИЗОБРАЖЕНИЕ	ОРИГ. №	KG	ИЗОБРАЖЕНИЕ	ОРИГ. №	KG
<b>ГЪРДИ</b>					
	001 765 Z	1,500		001 847Z	1,400
	001 766 Z	1,500		001 848Z	1,400
	073250	1,400		190 3693	1,800
	073251	1,400		037 985 0	1,800
	073256	1,600		190 3694	1,800
	073257	1,600		037 986 0	1,800
	190 2020	1,400		190 3695	1,200
	190 3562	1,000		PA 305 401	1,200
	190 3563	1,000		190 3696	1,200
HE	930 76 035.0	2,500		921 02 148 0	1,700
HE	930 77 035.0	2,500		921 02 158 0	1,700
<b>ПЪЛЪЦИ</b>					
	000805Z	4,400		001 763Z	9,100
	000806Z	4,400		001 764Z	9,100
	000813Z	4,000		073286	20,700
	000814Z	4,000		073287	20,700
	001497Z	6,500		073290	20,700
	001498Z	6,500		073291	20,700
	001499Z	5,300	HE	190 3559 Z	14,500
	001500Z	5,300	HE	190 3561 Z	14,500
HE	929 10 010 1	5,900		930 76 033.0	20,900
HE	941 95 0250	5,300		930 77 033.0	20,900
<b>ЗАЩИТИ ЗА ПЪЛЪЦ</b>					
HE	929 10 021 0	7,000			
HE	929 10 020 1	5,300			
	929 10 000 1	1,000			
	929 10 005 0	1,000			
	930 70 005 0	2,000			
	930 71 005 0	2,000			
<b>ЪГЛОСЛИМИ</b>					
	073300	3,300			
	073301	3,300			
<b>ЛЕМЕЖИ ЗА ПРЕДПЛУЖНО ТЯЛО</b>					
<b>ОТМЕТАТЕЛНИ ДЪСКИ</b>					
<b>ШИЛА</b>					
<b>ПЕТИ</b>					
	053090	1,300		063387	1,900
	063090	1,300		063388	1,900
	190 36 75	1,100			
	190 36 76	1,100			
	925 13 011 0	2,600			
	925 13 021 0	2,600			
	925 26 011 0	2,600			
	925 26 021 0	2,600			

LANDSBERG PÖTTINGER

ИЗОБРАЖЕНИЕ	ОРИГ. №	KG	
<b>ЛЕМЕЖИ</b>			
	000 849 Z 190 3020 925.03.000.0	3,600	
	000 850 Z 190 3030 925.04.000.0	3,600	
	000 851 Z 190 3040	4,600	
	000 852 Z 190 3050	4,600	
	001489Z, 1903100, 925.07.000.0	5,100	
	001 490 Z 190 3110, 925.08.000.0	5,100	
	006 766 D 190 3300 925.09.000.0	6,700	
	006 767 D 190 3310 925.10.000.0	6,700	
	010 513 Z 190 2740 925.05.000.0	4,800	
	010 514 Z 190 2750 925.06.000.0	4,800	
	010 515 Z, 190 3130, 925.32.000.0	4,500	
	010 516 Z, 190 3140, 925.33.000.0	4,500	
	041 782 Z 190 3557 925.21.000.0	4,100	
	041 783 Z 190 3558 925.22.000.0	4,100	

<b>ШИЛА</b>			
	041662 Z 940 95021 0	2,800	
	041663 Z 940 95031 0	2,800	

ИЗОБРАЖЕНИЕ	ОРИГ. №	KG	
<b>ЛЕМЕЖИ</b>			
	041 317 Z 190 36 71	4,600	
	041 318 Z 190 36 72	4,600	
	041 319 Z 190 36 73	5,200	
	041 320 Z 190 36 74	5,200	
	073004	5,500	
	073005	5,500	
	073006	6,100	
	073007	6,100	
	925 13 115 0 925 13 116 0	5,400	
	925 13 125 0 925 13 126 0	5,400	
	925 26 013 0/1 925 26 023 0/1	6,000	
	190 36 46	4,700	
	190 36 47	4,700	
	190 36 84	3,800	
	190 36 85	3,800	
	190 36 86	4,300	
	190 36 87	4,300	
	940 95 022 0	3,800	
	940 95 032 0	3,800	
	941 95 022 0	3,800	
	941 95 032 0	3,800	
	HE 942 95 002 0	4,300	
HE 942 95 012 0	4,300		

<b>РЕЗЦИ</b>			
	976 250 020 0	1,800	

<b>ДЪСКИ ЗА ПРЕДПЛУЖНО ТЯЛО</b>			
	190 36 97	2,500	
	190 36 98	2,500	

<b>ДЪРЖАЧИ ЗА ЪГЛОСЛИМ</b>			
	073310	2,300	
	073311	2,300	

ДИСКОВИ БРАНИ

Диск 530 mm за KDB PRINCESS Мадара

Изображение	Характеристики
	Диаметър : 530 mm Материал: Борова стомана Дискове с 4 отвора, назъбени. Подходящи за лагерно тяло SKF Agri Hub и за дискова брана Мадара Princess

Капсулована главина Agri Hub

Изображение	Характеристики
	Агро главината е напълно приложима за всички брани с индивидуални работни органи. Гумените пръстени от вътрешната страна служат за по-доброто разполагане на диска. Монтирането на дисковете става посредством 4 болта, които се завиват директно към главината, а тя от своя страна с по 1 гайка към всеки стълбец. <b>Функции:</b> • висококачествено капсуловане, което предотвратява проникването на кал, пепел и вода в лагерите. • качествени лагери, създадени да издържат на шоково натоварване. • покритието е устойчиво на корозия, торове и водната струя при почистване.

Макара(Дистанционна втулка) за дискова брана

Изображение	Характеристики
	Дистанционна втулка за брана. Размер: 220 mm Подходящи за дисковите брани на Попово, дискови брани "Перла"- Нова Загора и всички останали български марки

ОСИ ЗА ДИСКОВИ БРАНИ

Изображение	Размери $\varnothing$ mm
	30 x 30
	35 x 35
	40 x 40

ПРОДЪЛБОЧИТЕЛ

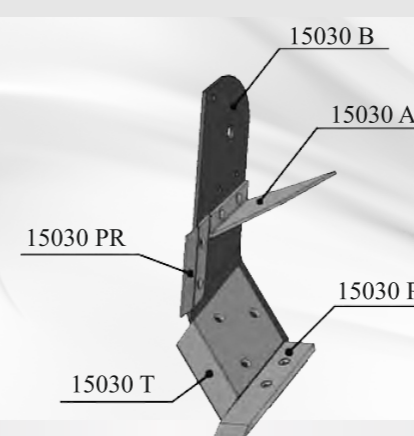

Номер	
Крило 15030-A D/I	
Стълбец 15030-B D/I	
Врх 15030-P	
Защита 15030-PR D/I	
Пета 15030-T D/I	
Комплект 15030 D/I	

ДИСКОВИ БРАНИ

Назъбени дискове  
от борова стомана



Диаметър		Тегло
mm	inch	кг
460	18"	3.650
510	20"	5.570
560	22"	7.810
610	24"	12.350
660	26"	15.000
660/8	26"	19.940
710	28"	17.780

Гладки дискове  
от борова стомана

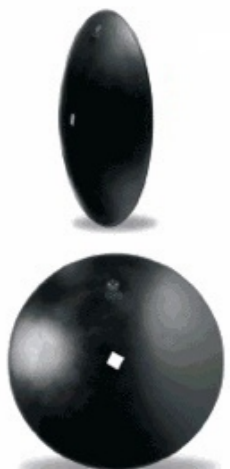

Диаметър		Тегло
mm	inch	кг
460	18"	4.140
510	20"	6.180
560	22"	8.620
610	24"	13.600
660	26"	16.630
660/8	26"	22.130
710	28"	19.530

Дискове за Lemken Rubin

349 0466      349 0467



	Диаметър	Дебелина	Тегло
	mm	mm	кг
349 0466	620	6	13,000
349 0467	620	6	12,450

Дискове за Amazone Catros

X1011      X1034



	Диаметър	Дебелина	Тегло
	mm	mm	кг
X1011	450	4	4,700
X1034	460	4	4,630

LEMKEN

ИЗОБРАЖЕНИЕ	ОРИГ. №	KG
<b>ЛЕНТИ ЗА ЛЕНТОВИ ДЪСКИ</b>		
	344 4010	3,000
	344 4011	3,000
	344 4012	4,800
	344 4013	4,800
	344 4020	3,000
	344 4021	3,000
	344 4030	4,400
	344 4031	4,400
	344 4040	4,400
	344 4041	4,400
	344 4042	7,500
	344 4043	7,500
	344 4110	5,100
	344 4111	5,100
	344 4120	4,000
	344 4121	4,000
	344 4130	4,800
	344 4131	4,800
	334 4134	4,200
	334 4135	4,200
	334 4140	7,100
	334 4141	7,100

<b>ЛЕМЕЖИ ЗА ПРЕДПЛУЖНО ТЯЛО</b>		
	336 3710 S270	1,400
	336 3711 S270	1,400
	336 3712 S150	0,900
	336 3713 S150	0,900
	336 3714 S185	1,100
	336 3715 S185	1,100
	336 3720 S190	1,100
	336 3721 S190	1,100
	336 3724 R/L	1,500

<b>ДЪСКИ ЗА ПРЕДПЛУЖНО ТЯЛО</b>		
	347 0564	2,300
	347 0565	2,300
	347 0600	4,000
	347 0601	4,000
	347 0620	2,300
	347 0621	2,300
	347 0650	1,500
	347 0651	1,500

<b>КЛИН</b>		
	3401900	1,100
	3401901	1,100







ИЗОБРАЖЕНИЕ	ОРИГ. №	KG
<b>ЛЕМЕЖИ</b>		
	335 1958	3,900
	335 1959	3,900
	335 2110	3,700
	335 2111	3,700
	335 2120	4,100
	335 2121	4,100
	335 2130	4,700
	335 2131	4,700
	335 2134	5,100
	335 2135	5,100
	335 2230 наварени	4,900
	335 2231 наварени	4,900
	333 3803	3,800
	333 3804	4,300
	333 3805	4,300
	333 3810	5,300
	333 3811	5,300
	333 3812	5,600
	333 3813	5,600





<b>ГЪРДИ</b>		
	345 0524	2,000
	345 0525	2,000
	345 1000	2,400
	345 1001	2,400
	345 1002	3,000
	345 1003	3,000
	345 1004	2,700
	345 1005	2,700
	345 1010	2,500
	345 1011	2,500

<b>ШИЛА</b>		
	336 4050	2,000
	336 4051	2,000
	336 4054	2,800
	336 4055	2,800
	336 4150 наварени	2,000
	336 4151 наварени	2,000
	336 5540	2,300
	336 5541	2,300

<b>КИНОВЕ И ПЕТИ</b>		
	347 6000	1,300
	347 6001	1,300

LEMKEN

ИЗОБРАЖЕНИЕ	ОРИГ. №	KG
<b>НОЖОВЕ</b>		
	349 2890	1,300
	349 2891	1,300
<b>ПЪЛЪЦИ</b>		
	340 1561	3,000
	340 1570	3,000
	341 1460	6,800
	341 1504	4,600
	341 1500	
	341 1508	5,900
	341 1826	5,000
	341 1870	7,300
	341 1871	7,300

ИЗОБРАЖЕНИЕ	ОРИГ. №	KG
<b>ОТМЕТАТЕЛНИ ДЪСКИ</b>		
	344 1030	13,000
	344 1031	13,000
	344 1034	15,800
	344 1035	15,800
	344 1040	16,200
	344 1041	16,200
<b>ЗАЩИТА ЗА ПЪЛЪЕЦ</b>		
	3401490	
<b>ЪГЛОСЛИМИ</b>		
	347 0860	3,100
	347 0861	3,100

MASSEY FERGUSON

ИЗОБРАЖЕНИЕ	ОРИГ. №	KG
<b>ЛЕМЕЖИ</b>		
	394 0330	3,000
	394 0334	3,000
	394 0332	3,200
	394 0335	3,200
	394 0314/85 381	4,400
	394 0312/85 383	4,400
	394 0345M1	4,500
	85 382	
	85 384	4,500
	394 0347M1	
HE	394 0706/94 598	3,300
HE	394 0707/94 599	3,300
	394 0708/94 600	4,100
	394 0709/94 601	4,100
<b>ОТМЕТАТЕЛНИ ДЪСКИ</b>		
	394 0744	16,900
	94 594	
	394 0743	16,900
	94 595	

ИЗОБРАЖЕНИЕ	ОРИГ. №	KG
<b>ГЪРДИ</b>		
	394 0704	1,400
	94 596	
	394 0705	1,400
	94 597	
<b>ПЪЛЪЦИ</b>		
	394 0712/94 604	5,200
	394 0713/94 604	5,200
<b>ЛЕМЕЖИ ЗА ПРЕДПЛУЖНО ТЯЛО</b>		
	394 0499/91801	1,500
	394 0500/91802	1,500
<b>ОТМЕТАТЕЛНИ ДЪСКИ ПРЕДПЛУЖНО ТЯЛО</b>		
	394 0500	2,100
	91 803	
	394 0501	2,100
	91 804	
<b>НОЖОВЕ</b>		
	394 0746/86725	1,300

ЧУКОВЕ

ЧУК CM-17



ЧУК CM-18



Номер	A (mm)	B (mm)	Радиус	Ø	Тегло(кг)
CM-17 Belafer	59,5	59,5	86	28,5	1,450
CM-18 Serrat	81	125	110	35	2,650

ЧУК CM-19



PUA GIROSPIC



Номер	A (mm)	B (mm)	Радиус	Ø	Тегло(кг)
CM-19	60	90	115	90	5,000
PUA GIROSPIC ГАЙКА M-22x2				22	0,900

ЧУК CM-20



ЧУК CM-21



Номер	A (mm)	B (mm)	Радиус	Ø	Тегло(кг)
CM-20 Jounes	69	157	95	22,5	2,200
CM-21 Agricom	40	116	105	18,5	1,300
CM-21 G	40	116	105	20,5	1,300

ЧУК CM-22



ЧУК CM-23



Номер	A (mm)	B (mm)	Радиус	Ø	Тегло(кг)
CM-22 Martin	50	157	110	20,5	2,250
CM-23 Agrimaster	40	60	134	26,5	2,250

ЧУК CM-24



ЧУК CM-26



Номер	A (mm)	B (mm)	Радиус	Ø	Тегло(кг)
CM-24 Ventura	70	100	100	18,5	1,300
CM-26 Fernandez	80	170	100	20,5	2,560

ЧУК CM-27



ЧУК CM-28



Номер	A (mm)	B (mm)	Радиус	Ø	Тегло(кг)
CM-27 Belafer	90	100	110	31,5	2,900
CM-28 Agric	62	71	115	35,5	2,500

ЧУК CM-29



ЧУК CM-30



Номер	A (mm)	B (mm)	Радиус	Ø	Тегло(кг)
CM-29	87,5	88,5	62,5	8,500	
CM-30 Enguix	30	120	26,00	1,350	

ЧУК CM-32



Номер	A (mm)	B (mm)	Радиус	Ø	Тегло(кг)
CM-32 Serrat	70	100	85	26,5	2,000

ЧУКОВЕ

ЧУК CM-01



ЧУК CM-02



Номер	A (mm)	B (mm)	Радиус	Ø	Тегло(кг)
CM-01 Berti	40	140	95	16,5	1,600
CM-01 G	40	140	95	18,5	1,600
CM-01 SG	40	140	95	20,5	1,600
CM-02 Siema	55	150	100	16,5	1,800

ЧУК CM-03



ЧУК CM-04



Номер	A (mm)	B (mm)	Радиус	Ø	Тегло(кг)
CM-03 P	40	120	110	16,5	1,350
CM-03 Kuhn	40	120	110	18,5	1,350
CM-04 Serrat	80	120	110	20,5	1,860

ЧУК CM-05



ЧУК CM-06



Номер	A (mm)	B (mm)	Радиус	Ø	Тегло(кг)
CM-05 Agrator	60	150	85	20,5	2,000
CM-06 Agricom Famma	72	162	160	20,5	2,400
CM-06 R	72	162	160	20,5	2,500
CM-06 RG.	72	162	160	22,5	2,500

ЧУК CM-07



ЧУК CM-08



Номер	A (mm)	B (mm)	Радиус	Ø	Тегло(кг)
CM-07 Mila	82	190	95	22,5	2,250
CM-07 P	82	190	95	20,5	2,250
CM-08 Agrator	87	224	75	20,5	2,700

ЧУК CM-09



ЧУК CM-10



Номер	A (mm)	B (mm)	Радиус	Ø	Тегло(кг)
CM-09	80	180	85	18,5	2,715
CM-10 Agarin	94	11	100	41	3,500

ЧУК CM-11



ЧУК CM-12



Номер	A (mm)	B (mm)	Радиус	Ø	Тегло(кг)
CM-11 Jonues	72	155	105	12,5	2,250
CM-12 AGRIC	87	208	90	20,5	2,250

ЧУК CM-13



ЧУК CM-14

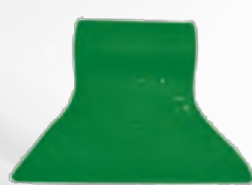

Номер	A (mm)	B (mm)	Радиус	Ø	Тегло(кг)
CM-13	55	96	175	26	2,310
CM-14 Belafer	90	150	105	20,5	2,900

ЧУК CM-15



ЧУК CM-16



Номер	A (mm)	B (mm)	Радиус	Ø	Тегло(кг)
CM-15 Gregorie	40	90	124	16,5	18,50
CM-03 Kuhn	59	68	80	18,5	30,5

NARDI

ИЗОБРАЖЕНИЕ	ОРИГ. №	KG
<b>ЛЕМЕЖИ</b>		
	5C54	
	5CS54	
	6C54	
	6CS54	
	7C54	
	7CS54	
	9C53	

ИЗОБРАЖЕНИЕ	ОРИГ. №	KG
<b>ПЕТИ</b>		
	5C182	
	6C182	
	7C183	
	7CS183	
	9C183	
	9CS183	
	10C184	
	12C184	
	13C184	

ИЗОБРАЖЕНИЕ	ОРИГ. №	KG
<b>ДЪРЖАЧИ ЗА ШИЛО</b>		
	5C83	
	6C83	
	12C83	

ИЗОБРАЖЕНИЕ	ОРИГ. №	KG
<b>ШИЛА</b>		
	5C63	
	5CS63	
	6C64	
	6CS64	
	9C36	
	9CS36	
	12C63	
	12CS63	

ИЗОБРАЖЕНИЕ	ОРИГ. №	KG
<b>ПЛЪЗЦИ</b>		
	5C115	
	5 1/2 C115	
	6C115L	
	8C115	
	5C115A	
	5 1/2 C115A	
	6C115A	
	8C115A	

ИЗОБРАЖЕНИЕ	ОРИГ. №	KG
<b>ОТМЕТАТЕЛНИ ДЪСКИ</b>		
	5C163B	
	5CS163BS	
	6C163B	
	6CS163BS	
	7C162B	
	7CS162BS	

NIEMEYER



ИЗОБРАЖЕНИЕ	ОРИГ. №	KG
<b>ПЛЪЗЦИ</b>		
	020619	4,000
	020620	4,000
	020627	5,000
	020628	5,000
	024004	1,000
	024072	5,100

ИЗОБРАЖЕНИЕ	ОРИГ. №	KG
<b>ЛЕМЕЖИ ЗА ПРЕДПЛУЖНО ТЯЛО</b>		
	026017	1,100
	026018	1,100
	026087	1,000
	026088	1,000
	026103	1,200
	026104	1,200

ИЗОБРАЖЕНИЕ	ОРИГ. №	KG
<b>ЛЕМЕЖИ</b>		
	200616 N15	5,000
	200617 N15	5,000
	200810 N18	5,600
	200811 N18	5,600
HE	200829 N17	5,200
	200830 N17	5,200
	200614 N 152	4,900
	200615 N 152	4,900
	200814 N 172	5,400
	200815 N 172	5,400
	024102 SH15G	4,100
	024103 SH15G	4,100
	024106 SH15G	4,400
	024107 SH15G	4,400
	024121 NH6G	4,600
	024122 NH6G	4,600

NIEMEYER

ИЗОБРАЖЕНИЕ	ОРИГ. №	KG
<b>ДЪСКИ ЗА ПРЕДПЛУЖНО ТЯЛО</b>		
	026273	1,800
	026274	1,800

<b>ЗЪБИ</b>		
	024104	1,300
	024105	1,300
	200678 SH15G	2,300
	200679 SH15G	2,300

<b>ПЪЛЪЦИ</b>		
	026248	5,400

<b>НОЖОВЕ ЗА ПЪЛЪЕЦ</b>		
	026240	1,900
	026241	1,900

ИЗОБРАЖЕНИЕ	ОРИГ. №	KG
<b>ОТМЕТАТЕЛНИ ДЪСКИ</b>		
	N 15G-753 020737	9,600
	N 15G-754 020738	9,600

<b>ЛЕНТИ ЗА ЛЕНТОВА ДЪСКА</b>		
	024125-втора	4,400
	024126-втора	4,400
	024127-трета	3,000
	024128-трета	3,000
	024129-първа	8,400
	024130-първа	8,400
	024131-четвърта	3,500
	024132-четвърта	3,500

<b>ГЪРДИ</b>		
	024080	2,800
	024081	2,800
	200745	2,600
	200746	2,600

ÖVERUM

ИЗОБРАЖЕНИЕ	ОРИГ. №	KG	ЦЕНА/ЛВ.
<b>ОТМЕТАТЕЛНИ ДЪСКИ ЗА ПРЕДПЛУЖНО ТЯЛО</b>			
	91803	2,100	
	91804	2,100	

<b>ЛЕМЕЖИ ЗА ПРЕДПЛУЖНО ТЯЛО</b>			
	91801	1,500	
	91802	1,500	

<b>ОТМЕТАТЕЛНИ ДЪСКИ</b>			
<b>HE</b>	74930	13,500	
	80604	15,000	
	84087	13,400	
	94594	16,900	
	94595	16,900	

ИЗОБРАЖЕНИЕ	ОРИГ. №	KG
<b>ОТМЕТАТЕЛНИ ДЪСКИ ЗА ПРЕДПЛУЖНО ТЯЛО</b>		
	96064	3,900
	96065	3,900

<b>ПЕТИ</b>		
	74922	1,600
	80559	1,600

<b>ВЪРХОВЕ</b>		
	74601	3,400

<b>НОЖОВЕ</b>		
	86725	1,300
	94622	1,200
	94623	1,200

КУЛТИВАТОРНИ ЛАПИ И ШИЛА



Номер	A (mm)	B (mm)	Деб.(mm)	Тегло(кг)
535 - B S/N	70	345	10	1,725
535 - 4 2a/3a	100	370	11	2,350

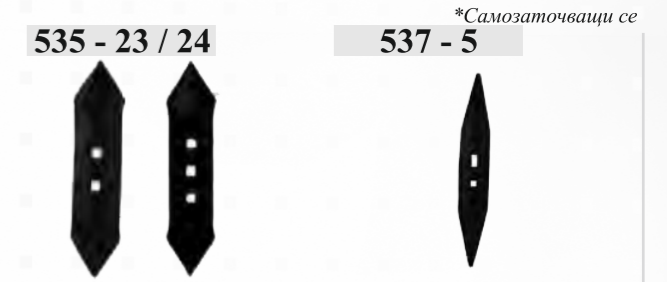

Номер	A (mm)	B (mm)	Деб.(mm)	Тегло(кг)
535 - 23	60	270	8	0,940
535 - 24	70	340	10	1,600
537 - 5 S/N	75	395	13	2,100
537 - 5 SN/ A.R.	75	395	13	2,100
537 - 5 CN A.R.	60	390	14	2,450



Номер	A (mm)	B (mm)	Деб.(mm)	Тегло(кг)
513 - 0 T11	240	190	5	0,950
593 - C4 8	355	240	8	2,150

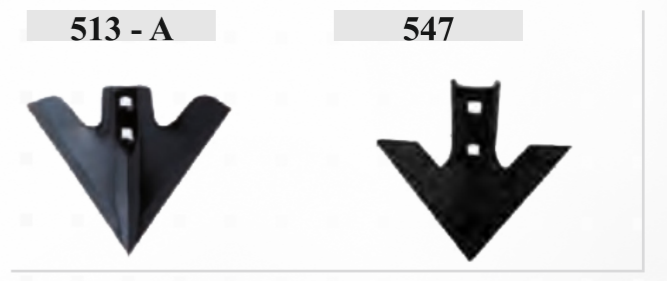

Номер	A (mm)	B (mm)	Деб.(mm)	Тегло(кг)	Цена
513 - A S/N	280	225	6	1,400	
513 - A T-11	280	225	6	1,400	
513 - A C/N	280	220	7	1,600	
547	210	150	6	0,700	

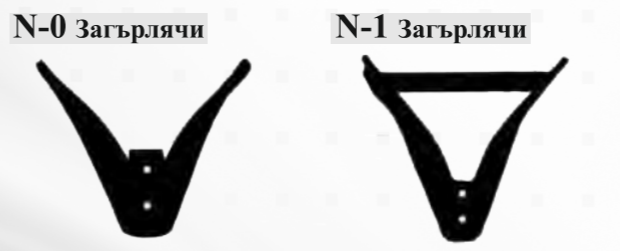

Номер	A (mm)	B (mm)	Деб.(mm)	Тегло(кг)
N - 0	210	190	8	1,410
N - 1	310	270	8	3,450
N - 3(AIVEQUILHO)	240	310	4	2,475
N - 3A(AIVEQUILHO)	330	380	4	3,790



Номер	A (mm)	B (mm)	Деб.(mm)	Тегло(кг)
Lemken G25	250	170	5	0,800
561 - 0	230	330	8	2,900
561 - 1	280	340	8	3,160
561 - A	350	360	8	4,000
561 - 4	400	37	8	4,300



Номер	A (mm)	B (mm)	Деб.(mm)	Тегло(кг)
535 - C S/N	90	345	10	2,350
R - 1	180	380	10	2,880
R - 2	240	370	10	3,580

КУЛТИВАТОРНИ ЛАПИ И ШИЛА

\*Самозаточващи се

47



Номер	A (mm)	B (mm)	Деб.(mm)	Тегло(кг)
544 C/N	200	1.800	6	0,650
302007	150	110		0,400
302008	175	115		0,450
302009	200	120		0,500
302010	250	130		0,600

3020



547 - 1C/N



Номер	A (mm)	B (mm)	Деб.(mm)	Тегло(кг)
547 - 1C/N	200	115	6	0,500
547 C/N	210	150	6	0,700

547 C/N



552 C/N



Номер	A (mm)	B (mm)	Деб.(mm)	Тегло(кг)
552 C/N	155	152	6	0,510
553 C/N	136	150	6	0,520

553 C/N



505 C/N



Номер	A (mm)	B (mm)	Деб.(mm)	Тегло(кг)
505 C/N	40	240	6	0,480
5000 C/N	58	260	6	0,710
5000 C/N 2T	58	260	6	0,750

5000 C/N



549 C/N



Номер	A (mm)	B (mm)	Деб.(mm)	Тегло(кг)
549 C/N	45	235	8	0,710
549-G C/N	55	290	8	0,750
543 C/N	35	200	6	0,400

543 C/N



549 - 1



Номер	A (mm)	B (mm)	Деб.(mm)	Тегло(кг)
549 - 1	50	237	6	0,500
529	45	170	7	0,360
530 C/N	55	280	8	0,815

529



530



535 - A S/N



Номер	A (mm)	B (mm)	Деб.(mm)	Тегло(кг)
535 - A S/N	70	275	10	1,300
535 - A C/N	70	275	12	1,500
535 - O C/N	60	290	12	1,350

535 - A C/N



543



Номер	A (mm)	B (mm)	Деб.(mm)	Тегло(кг)
543	40	200	7	0,650
549	45	235	7	0,700

549



ÖVERUM

ИЗОБРАЖЕНИЕ	ОРИГ. №	KG
<b>ПЛЪЗЦИ</b>		
	74602	2,000
	74612	2,000
	80603	5,900
	83981	3,900
	85196	3,900
	85118	4,800
	94286	4,800
	85197	4,800
	94285	4,800
	94604	5,200
	94605	5,200
	94606	5,200
	94607	5,200
	96094	
	96095	

<b>ШИЛА</b>		
	84060	2,300
	85143	2,300
	94608	2,300
	94609	2,300

<b>ГЪРДИ</b>		
	21470	3,200
	21599	3,200
	74871	2,000
	80609	2,000
	94596	1,400
	94597	1,400

<b>ДЪРЖАЧ ЗА ВРЪХ</b>		
	94612	
	94613	

<b>ДЛЕТА</b>		
	85204	2,200
	94610	2,300
	94611	2,300

ИЗОБРАЖЕНИЕ	ОРИГ. №	KG
<b>ЛЕМЕЖИ</b>		
	84069	3,300
	84078	3,300
	85004	3,000
	85194	3,000
	85039	3,200
	85195	3,200
	85381	4,400
	85383	4,400
	85382	4,500
	85384	4,500
	94598	3,300
	94599	3,300
	94600	4,100
	94601	4,100
	94602	3,900
	94603	3,900
	72633	
	74605	3,700
	74606	4,100
	74607	4,500
	74903	4,200
	74904	4,100
	96092	3,900
	96093	3,900

<b>ЛЕНТИ ЗА ЛЕНТОВА ДЪСКА</b>		
	20249	2,600
	20894	
	20250	3,100
	20895	
	20251	3,700
	20896	
	20252	6,200
	20897	

OVLAC

ИЗОБРАЖЕНИЕ	ОРИГ. №	KG
<b>ГЪРДИ</b>		
	1839 D / I	2,600
	1849 D / I	1,800
	1798 D / I (3 отв.)	1,500

ИЗОБРАЖЕНИЕ	ОРИГ. №	KG
<b>ЛЕНТИ ЗА ЛЕНТОВИ ДЪСКИ</b>		
	18057-ПЪРВА	2,900
	18056-ВТОРА	3,100
	18055-ТРЕТА	4,500
	18054-ЧЕТВЪРТА	7,300

OVLAS

ИЗОБРАЖЕНИЕ	ОРИГ. №	KG
<b>ЛЕМЕЖИ</b>		
	1434-17 D	5,500
	1434-17 I	5,500
	1434-18 D	6,300
	1434-18 I	6,300
	1374-16 D	5,300
	1374-16 I	5,300
	1394 D	1,600
	1394 I	1,600



ОТМЕТАТЕЛНИ ДЪСКИ		
	1840 D / I	15,400
	1834 D / I	20,700

ЪГЛОСЛИМИ		
	1856 D	3,100
	1856 I	3,100

ИЗОБРАЖЕНИЕ	ОРИГ. №	KG
<b>ПЪЛЪЦИ</b>		
	2338	4,100
	2339	5,200
	18062 D	1,000
	18062 I	1,000
	18063	4,500





ОТМЕТАТЕЛНИ ДЪСКИ		
	1797 D / I	20,900
	1874 D / I	14,200

RABE

ИЗОБРАЖЕНИЕ	ОРИГ. №	KG
<b>ШИЛА</b>		
	MP 293	0,800
	MP 293 L	0,800
	MP 332	1,200
	MP 332 L	1,200
	MP 350	1,200
	MP 350L	1,200

ОТМЕТАТЕЛНИ ДЪСКИ		
	HRP 235-0	8,800
	HRP 235-0L	8,800
	HRP 295-0	19,000
	HRP 295-0L	19,000
	HRP 326-P	19,000
	HRP 326-PL	19,000
	HRP 327-P Li	14,700
	HRP 327-P Re	14,700
	HRP 350 W	20,800
	HRP 350 WL	20,800

ЗАЩИТИ ЗА ПЪЛЪЕЦ		
	XP-4	0,900
	XP-6	3,200

ИЗОБРАЖЕНИЕ	ОРИГ. №	KG
<b>ГЪРДИ</b>		
	VRP 404	1,800
	VRP 230-0	1,900
	VRP 230-0L	1,900
	VRP 342-0	1,900
	VRP 342-0L	1,900
	VRP 350 WL	2,800
	VRP 350 WR	2,800
	VRP 342R	2,800
	VRP 342RL	2,800

ВРЪХ ЗА ПЪЛЪЕЦ		
	YP 350 W	1,200

КУЛТИВАТОРНИ ЛАПИ И ШИЛА

\*Самозаточващи се

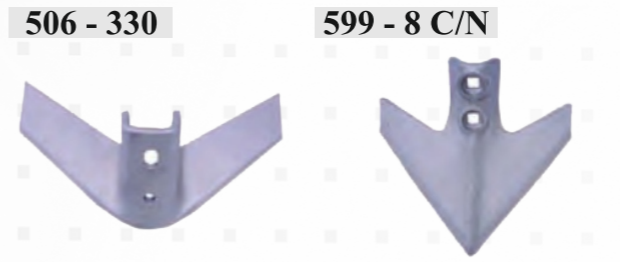

Номер	A (mm)	B (mm)	Деб.(mm)	Тегло(кг)
506-330	290	192	8	2,150
599-8 CN	260	222	8	2,000



Номер	A (mm)	B (mm)	Деб.(mm)	Тегло(кг)
544 C/N	105	120	6	0,310
548 C/N D/I	125	115	6	0,430



Номер	A (mm)	B (mm)	Деб.(mm)	Тегло(кг)
502 - 8 C/N	70	288	8	1,250
502 - 8	70	288	8	1,150
502 - 9 C/N	105	335	8	1,690

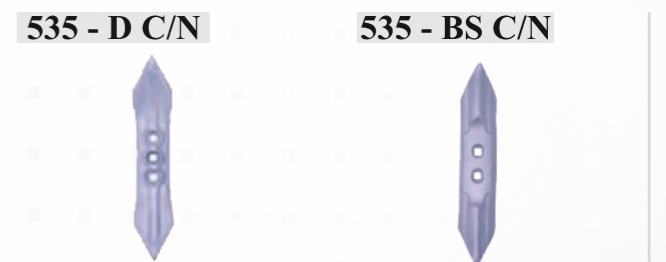

Номер	A (mm)	B (mm)	Деб.(mm)	Тегло(кг)
535-D C/N	82	410	12	3,050
535-BS C/N 2T	75	345	12	2,000
535-BS C/N 3T	75	345	12	2,000

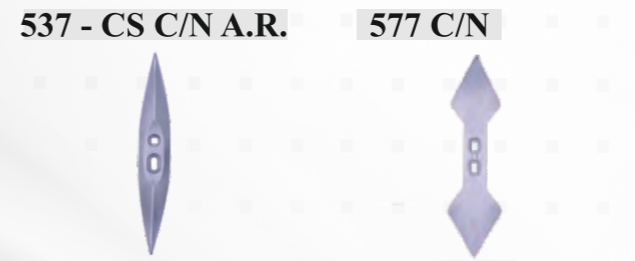

Номер	A (mm)	B (mm)	Деб.(mm)	Тегло(кг)
537 - CS C/N A.R.	70	400	24	2,900
577 C/N	130	530	12	3,330

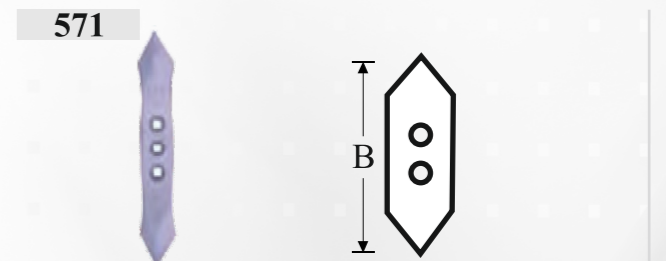

Номер	A (mm)	B (mm)	Деб.(mm)	Тегло(кг)
571 - B	55	400	20	2,900
571 - C	60	400	20	3,000



Номер	A (mm)	B (mm)	Деб.(mm)	Тегло(кг)
S-49		"Sola"		0,950
S-200		"Sola"		1,300



Номер	A (mm)	B (mm)	Деб.(mm)	Тегло(кг)
535-B R3 C/N 2A	75	340	12	2,000
535-B R3 C/N 3A	75	340	12	2,000
535-C R3 C/N 90	90	350	12	2,550



ПРУЖИНИ ЗА ИГЛЕНА БРАНА

Пружина за иглена брана двойна

Пружина за иглена брана единична

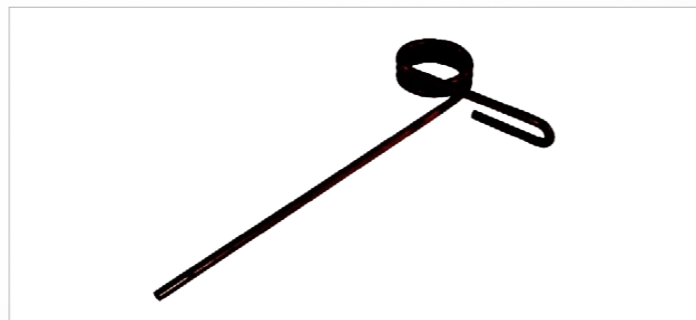

Номер	A (mm)	B (mm)	Деб.(mm)
7 mm D/T	120	300	7
8 mm D/T	130	300	8
9 mm D/T	130	320	9
9 mm T 125	125	415	9
10 mm D/T	145	320	10
10 mm T-45		450	10

Номер	B (mm)	Деб.(mm)
7mm D/T	300	7
8mm D/T	300	8
9mm D/T	320	9
10mm D/T	320	10
12mm	440	12
Държач за греда 50x50		10

КУЛТИВАТОРНИ ЛАПИ И ШИЛА

\*Самозаточващи

513 - 0 C/N



Номер	A (mm)	B (mm)	Деб.(mm)	Тегло(кг)
513-0 C/N	240	190	5	1,400

513 - A



Номер	A (mm)	B (mm)	Деб.(mm)	Тегло(кг)
513-A S/N 8	280	240	8	2,000

513 - A C/N



513-A C/N 8 mm	290	220	8	2,100
513-A C/N 10 mm	290	220	10	2,600

593 - C4 C/N



Номер	A (mm)	B (mm)	Деб.(mm)	Тегло(кг)
593-C4 C/N	355	240	8	2,450
593 C/N	400	275	8	2,500
594 C/N DI	250	275	8	2,000

593 C/N



513 B - C/N



Номер	A (mm)	B (mm)	Деб.(mm)	Тегло(кг)
513-B C/N	310	280	8	2,700

513 C - C/N



513-C C/N	300	280	8	2,575
-----------	-----	-----	---	-------

РАВЕ

ИЗОБРАЖЕНИЕ	ОРИГ. №	KG
<b>ЛЕМЕЖИ</b>		
	SSP 293 OS	6,400
	SSP 293 OSL	6,400
	SSP 294 OS	7,500
	SSP 294 OSL	7,500
	SSP 332 OS	5,100
	SSP 332 OSL	5,100
	SSP 333 OS	5,400
	SSP 333 OSL	5,400
	SSP 350 WSE	6,700
	SSP 350 WSEL	6,700
	SSP 200 JB	4,200
	SSP 200 JBL	4,200
	SSP 293 0	6,600
	SSP 293 0L	6,600
	SSP 294 0	7,000
	SSP 294 0L	7,000
	SSP 332 0	4,800
	SSP 332 0L	4,800
	SSP 350 W	7,500
	SSP 350 WL	7,500
	SSP 351 WE	8,500
	SSP 351 WEL	8,500
HE	SSP 351 WEP	8,500
HE	SSP 351 WEPL	8,500
HE	SSP 401 F	7,800



<b>ПЛЪЗЦИ</b>		
	WP 365	5,100
	VP 202 0	2,500
	VP 292 0	3,500
	VP 351 W	3,500
	WP 203 0	3,900
	WP 292 0	5,500
	WP 351 W	5,800
	WP 380 P	8,500

<b>ЛЕМЕЖИ ЗА ПРЕДПЛУЖНО ТЯЛО</b>		
	SDG 14 /16	0,800
	SDG 14 /16 L	0,800
	SDG 181	0,900
	SDG 181 L	0,900

ИЗОБРАЖЕНИЕ	ОРИГ. №	KG
<b>ЛЕНТИ ЗА ЛЕНТОВА ДЪСКА</b>		
	SRP 236 01	1,900
	SRP 236 0L1	1,900
	SRP 236 02	2,000
	SRP 236 0L 2	2,000
	SRP 236 03	3,000
	SRP 236 0L 3	3,000
	SRP 236 04	2,800
	SRP 236 0L 4	2,800
	SRP 236 0B 4	4,600
	SRP 236 0BL 4	4,600
	SRP 327 PB 4	7,900
	SRP 327 PBL 4	7,900
	SRP 328 P 1	3,600
	SRP 328 PL 1	3,600
	SRP 328 P 2	3,800
	SRP 328 PL 2	3,800
	SRP 328 P 3	5,800
	SRP 328 PL 3	5,800
	SRP 328 P 4	5,300
	SRP 328 PL 4	5,300
	SRP 330 W1	3,500
	SRP 330 W1L	3,500
	SRP 330 W2	3,000
	SRP 330 W2L	3,000
	SRP 330 W3	3,800
	SRP 330 W3L	3,800
	SRP 330 W4	5,900
	SRP 330 W4L	5,900
	SRP 350 W1	3,900
	SRP 350 W1L	3,900
	SRP 350 W2	4,300
	SRP 350 W2L	4,300
	SRP 350 W3	5,500
	SRP 350 W3L	5,500
	SRP 350 W4	7,700
	SRP 350 W4L	7,700

<b>ДЪСКИ ЗА ПРЕДПЛУЖНО ТЯЛО</b>		
	RDG 181	1,800
	RDG 181L	1,800

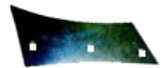
REGENT-BERGER

ИЗОБРАЖЕНИЕ	ОРИГ. №	KG
<b>ОТМЕТАТЕЛНИ ДЪСКИ</b>		
HE	2260 214-1	13,500
HE	2260 214-2	13,500
	2270 311-1	14,700
	2270 311-2	14,700
<b>ПЛЪЗЦИ</b>		
HE	1600 111-1 1600 118-1	
HE	1600 111-2 1600 118-2	
HE	165 0117-1/2	
HE	165 0219-1/2	
<b>ГЪРДИ</b>		
	2260 126-1	2,400
	2260 126-2	2,400
<b>ЗЪБИ</b>		
	DWS L	1,600
	DWS R	1,600

ИЗОБРАЖЕНИЕ	ОРИГ. №	KG
<b>ЛЕМЕЖИ</b>		
	DU 440 SL	4,800
	DU 440 SR	4,800
HE	DW 30 SL/SR	3,500
HE	DW 35 SL/SR	4,500
HE	DW 40 SL/SR	4,600
HE	DW 440 SL/SR	4,800
HE	DU 28 S	3,800
HE	DU 30 SL/SR	4,500
HE	DU 35 SL/SR	4,700
	DU 40 SL	5,100
	DU 40 SR	5,100
HE	DU 433 SL/SR	4,700
	DU 435 SL	4,700
	DU 435 SR	4,700
<b>ЛЕМЕЖИ ЗА ПРЕДПЛУЖНО ТЯЛО</b>		
	MSL	1,300
	MSR	1,300





UNIA

ИЗОБРАЖЕНИЕ	ОРИГ. №	KG
<b>ЛЕМЕЖИ</b>		
HE	11 1761 1000	6,100
HE	11 1751 1000	6,100
	10 6791 100	6,400
	10 6792 100	6,400

ИЗОБРАЖЕНИЕ	ОРИГ. №	KG
<b>ШИЛА</b>		
	1067 27 0000	1,800
	1067 28 0000	1,800

VOGEL & NOOT

ИЗОБРАЖЕНИЕ	ОРИГ. №	KG
<b>ГЪРДИ</b>		
	NI0 240 80	2,800
	NI0 240 81	2,800
HE	P58 001 03	1,900
	PK0 001 02P	2,000
	PK0 002 02P	2,000
	PK3 001 03BP	1,600
	PK3 002 03BP	1,600

ИЗОБРАЖЕНИЕ	ОРИГ. №	KG
<b>ГЪРДИ</b>		
	PK4 001 03BP	1,700
	PK4 002 03BP	1,700
	PK5 001 03BP	1,900
	PK5 002 03BP	1,900
	PK6 005 00BP	1,000
	PK6 006 00BP	1,000
	PK8 005 01P	2,200
	PK8 006 01P	2,200

РАБОТНИ ОРГАНИ ЗА КУЛТИВАТОРИ НОВ ВИД



**Най - надеждните пружини за култиватор от ново поколение. Комплектът включва:**

1	Пружина с размери 60 x 8 mm
2	Крак-квадрат 20 x 20 mm
3	Лапа с размер 200 mm
4	2 високоякостни болта + гайки за захващане към гредата
5	2 високоякостни болта + гайки за лястовичката
6	1 високоякостен болт + гайка захващане квадратният крак към пружината

СИСТЕМА ЗА ЧИЗЕЛ

Система с пружинна защита и специално закален крак, лесна за монтаж и поддръжка.



Възможност за монтиране на клиновиден работен орган за разрохване и стрелковиден за слята обработка. Позволява перфектно копиране на терена.

HORSCH MULCH-MIX



Криле	
340 60854	340 60856
340 60855	340 60857
Загръщач	
340 60852	340 60858
340 60853	340 60859
Шила	
340 60580	
003 10915 Terrano	
340 60850 Пластина	

СИСТЕМА ЗА БРАНА С ИНДИВИДУАЛНИ РАБОТНИ ОРГАНИ

Състои се от пружина защита и специално закален крак за перфектно копиране на терена, лагерно тяло с лагери 30206 и 30209. Подходяща за греди с размери 80x80, x100, x120.

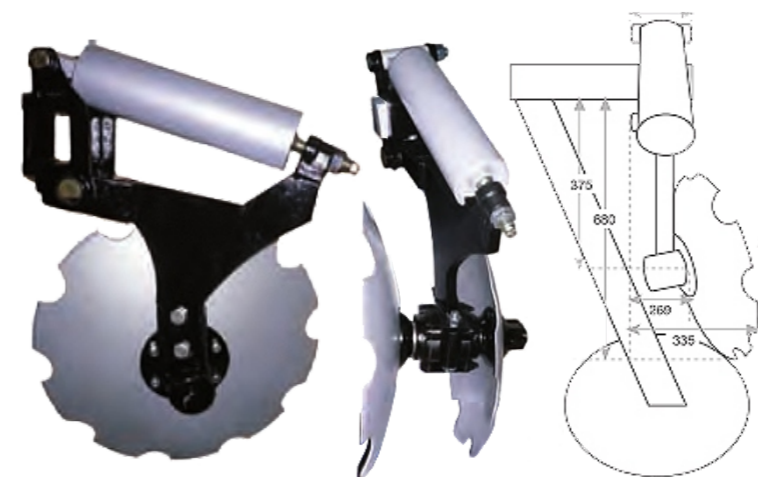

Препоръчителна дистанция при монтаж 230-250мм



Предлага се в два варианта:

Информация
<b>Единично лагерно тяло и диск:</b>
560 мм (22`x 6 mm)
610 мм (24`x 6 mm)
660 мм (26`x 6 mm)
<b>Двойно лагерно тяло и дискове</b>
510 / 610 mm
560 / 660 mm

**ПРУЖИНИ И СТЬЛЪЦИ ЗА КУЛТИВАТОРИ**



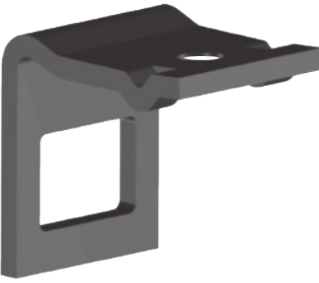

Изображение	Номер	А / mm (височина до гредата)	В / mm (цялата височина)	Ширина	Дебелина	Тегло
<b>Пружини за култиватор - КВАДРАТ</b>						
	20 x 20 леви и десни	330	420	20 mm	20 mm	4,500 kg.
	25 x 25 леви и десни	390	460	25 mm	25 mm	8,650 kg.
	27 x 27 леви и десни	410	500	27 mm	27 mm	10,500 kg.
	30 x 30 леви и десни	315	645	30 mm	30 mm	14,900 kg.
	32 x 32 леви и десни	460	520	32 mm	32 mm	17,530 kg.
	35 x 35 леви и десни	410	575	35 mm	35 mm	22,000 kg.
	40 x 40 леви и десни	415	685	40 mm	40 mm	33,900 kg.





**СКОБИ**

Изображение	За греда	Тегло
<b>Скоби за пружини на култиватор</b>		
<b>Скоби за пружини 32x10 / 32x12</b>		
	50x50	0,230 kg.
	60x60	0,480 kg.
	50x12	0,070 kg.
<b>Скоби за пружини 45x12</b>		
	60x60	0,680 kg.
<b>Скоби за пружини - квадрат</b>		
	60x60 за квадрат (20x20)	1,000 kg.
	70x70 за квадрат (25x25)	1,175 kg.
	80x80 за квадрат (25x25)	2,050 kg.
	90x90 за квадрат (27x27)	2,450 kg.
	100x100 за квадрат (32x32)	2,775 kg.



**VOGEL & NOOT**

ИЗОБРАЖЕНИЕ	ОРИГ. №	KG
<b>ЗЪБИ</b>		
HE	P90 034 02K	1,400
	PK8 011 01P	1,300
	PK8 011 02P	1,300
	PK8 011 01AP	1,700
	PK8 011 02AP	1,700
	PK8 011 01DP	1,900
	PK8 011 02DP	1,900
	024104	1,300
	024105	1,300
	200678 SH15G	2,300
	200679 SH15G	2,300

<b>ДЪСКИ ЗА ПРЕДПЛУЖНО ТЯЛО</b>		
	LZ1 051 02P	3,000
	LZ1 052 02P	3,000
	LZ1 366 02P	1,800
	LZ1 367 02P	1,800
	LZ1 376 02P	2,700
	LZ1 377 02P	2,700
	PA3 054 02P	2,500
	PA3 05502P	2,500

<b>ЗАЩИТИ</b>		
	026248	5,400
	P50 001 07	3,700
	P58 009 01P	5,000
	P58 011 01P	3,200
	PR7 030 01P	1,100

ИЗОБРАЖЕНИЕ	ОРИГ. №	KG
<b>ПЪЛЪЦИ</b>		
	024072	5,100
	P89 034 01P	3,400
	P89 035 01P	3,400
	P89 036 01P	5,400
	P89 037 01P	5,400
	PK8 034 01	4,100
	PK8 035 01	4,100
	PK8 130 03P	2,600
	PK8 140 03P	2,600
	PR7 030 02P	4,800
	PR7 030 03P	2,800

<b>ОТМЕТАТЕЛНИ ДЪСКИ</b>		
	P90 030 02P	12,000
	P90 031 02P	12,000
	P91 030 02P	13,700
	P91 031 02P	13,700
	PK3 001 02BP	11,500
	PK3 002 02BP	11,500
	PK4 001 02BP	13,900
	PK4 002 02BP	13,900
	PK5 001 02BP	18,500
	PK5 002 02BP	18,500
	PK7 001 01P	16,500
	PK7 002 01P	16,500
	PK8 001 09BP	19,600
	PK8 002 09BP	19,600
PK8 001 01BP	20,600	
PK8 002 01BP	20,600	

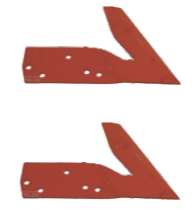
<b>НОЖОВЕ ЗА ПЪЛЪЦ</b>		
	026240	1,900
	026241	1,900
	PK2 015 01P	3,500
	PK2 016 01P	3,500
	PK2 017 01P	3,700
	PK2 018 01P	3,700

<b>ПЕТИ</b>		
	PK8 001 02P	1,400
	PK8 002 02P	1,400

VOGEL & NOOT

ИЗОБРАЖЕНИЕ	ОРИГ. №	KG
<b>ЛЕМЕЖИ</b>		
	WSM 40 R	6,200
	WSM 40 L	6,200
	WSM 43 R	6,400
	WSM 43 L	6,400
	WXM 40 R	5,100
	WXM 40 L	5,100
	WXM 43 R	6,400
	WXM 43 L	6,400
	UNM 35 R	5,100
	UNM 35 L	5,100
	UNM 40 R	5,600
	UNM 40 L	5,600
	UNM 43	5,900
	UNM 43 L	5,900
	WSM 35 R	5,100
	WSM 35 L	5,100
	HE WSM 430	5,400
	HE WSM 430 L	5,400
	W 300 RE	4,100
	WS 400 R	6,400
	WS 400 L	6,400
	WS 430 R	6,700
	WS 430 L	6,700
	U 1500 R	5,000
	U 1500 L	5,400
	WY 25	4,100
	WY 25 L	4,100
	UN 400 R3	5,400
	UN 400 L	5,400
	UN 430 R3	5,500
	UN 430 L3	5,500
	NI0 241 21	4,600
	NI0 241 22	4,600
	WY 3500	5,000
	WS 350 R3	5,100
	WS 350 L3	5,100
	UN 350	5,000
	UN 350 L	5,000

ИЗОБРАЖЕНИЕ	ОРИГ. №	KG
<b>ЛЕНТИ ЗА ЛЕНТОВА ДЪСКА</b>		
	NI0 241 25-втора	4,400
	NI0 241 26-втора	4,400
	NI0 241 27-трета	3,000
	NI0 241 28-трета	3,000
	NI0 241 29-първа	8,400
	NI0 241 30-първа	8,400
	NI0 241 31-четвърта	3,500
	NI0 241 32-четвърта	3,500
	PR0 001 01-първа	3,500
	PR0 002 01-първа	3,500
	PR0 001 02-втора	3,600
	PR0 002 02-втора	3,600
	PR0 001 03-трета	2,700
	PR0 002 03-трета	2,700
	PR0 001 04-четвърта	2,000
	PR0 002 04-четвърта	2,000
	PR3 001 01-първа	4,700
	PR3 002 01-първа	4,700
	PR3 001 02-втора	5,000
	PR3 002 02-втора	5,000
	PR3 001 03-трета	3,800
	PR3 002 03-трета	3,800
	PR3 001 04-четвърта	4,100
	PR3 002 04-четвърта	4,100
	PR9 001 01-първа	8,300
	PR9 002 01-първа	8,300
	PR9 001 02-втора	4,300
	PR9 002 02-втора	4,300
	PR9 001 03-трета	3,000
	PR9 002 03-трета	3,000
	PR9 001 04-четвърта	3,600
	PR9 002 04-четвърта	3,600



<b>ЛЕМЕЖИ ЗА ПРЕДПЛУЖНО ТЯЛО</b>		
	LZ1 356 01	1,700
	LZ1 357 01	1,700

ПРУЖИНИ И СТЬЛБЦИ ЗА КУЛТИВАТОРИ

Изображение	Номер	А (височина до гредата) mm	В (цялата височина)	Ширина	Дебелина	Тегло
<b>Пружини за култиватор</b>						
	476(25x8)	270	370	25 mm	8 mm	1,800 kg.
	470(32x10)	345	490	32 mm	10 mm	2,700 kg.
	472(32x12)	345	490	32 mm	12 mm	3,200 kg.
	472(32x12) два отвора	345	490	32 mm	12 mm	3,200 kg.
476(45x12)	447	609	45 mm	12 mm	5,200 kg.	
<b>Усилваща пружина</b>						
	474(32x12)	200	122	32 mm	12 mm	1,600 kg.
	474(45x12)	229	127	45 mm	12 mm	1,950 kg.
<b>Пружини за култиватор</b>						
	473(32x10)	237	330	32 mm	10 mm	1,700 kg.
<b>Усилваща пружина</b>						
	432(32x10)	190	130	32 mm	10 mm	1,330 kg.
<b>Стълбец за руски култиватори</b>						
			430	16 mm	16 mm	2,650 kg.